



WarmlyYours

Be Connected.
Be Warm. Be Radiant.

PRODUCT CATALOG



Towel Warmer Collection



Table of Contents

About WarmlyYours	3
<hr/>	
Towel Warmers	
Classic Collection	5
Elevate Collection	22
<hr/>	
Crystal Towel Warmer Accents	26
<hr/>	
Hardwired Controls	32
<hr/>	
Towel Warmer Showroom Display Program	33



About WarmlyYours Heating

Frequently, we are asked how we chose the name of our company. When we began as an electric radiant heating products business over 20 years ago, we wanted a name that would embody the very essence of our business philosophy – treat our customers well and offer the very best floor-warming systems and services in the industry. And above all else, always deliver on those promises to our customers.

The name WarmlyYours reflects our deep, personal commitment to providing our customers with the exceptional customer service that they deserve. We welcome any questions and relish the opportunity to provide our customers with prompt and friendly assistance.

Listening to feedback from thousands of homeowners and installers, we continue to improve on everything we do in our effort to better serve our customers. As a result, we have expanded our portfolio to include other radiant heating products – such as towel warmers and radiant panel heaters – to bring comfort and affordable luxury to all areas of the home.

WarmlyYours Advantage

WarmlyYours has locations in both the United States and Canada. Throughout North America, our customers recognize our commitment to exceptional service and product quality.

99% ★★★★★
of our customers report complete satisfaction with our service

97% ★★★★★
of our customers report complete confidence in our product quality



24/7 Installation Support

Call us any time — day or night, weekday or weekend — with any questions or installation challenges. Our technical support team is here to help. That's our commitment to our customers and their businesses.



Same-Day Shipping

For US orders shipping via parcel, simply submit your order by these times and we will process your order and have it on its way by the end of the day:

- 4 PM Central Time for UPS and FedEx
 - 2 PM Central Time for SpeedDee
 - 12 PM Central Time for USPS
 - 9 AM Central Time for Freight
-



Open Return Policy & No Restocking Fees

Our return policy is simple. If we still sell the product and it's in resalable condition, you may return it at any time — even years later. We do not have restocking fees for any of our products. We know that life does not always run according to an ideal schedule, and at WarmlyYours, you come first.

Classic Collection



The **Classic Towel Warmer Collection** is sold directly by WarmlyYours and Authorized Retailers.

Shop the Classic Collection at
[WarmlyYours.com/towel-warmer](https://www.warmlyyours.com/towel-warmer)

The Elements

The Elements Towel Warmer by WarmlyYours offers a stylish 4-bar configuration making it perfect for any bathroom in your home.

The sleek and classic serpentine loop design allows towels to slide on and off easily. Simply elegant, with a beautifully polished chrome finish, this high-quality wall mount unit will keep your towels warm and dry.

- Sleek, classic serpentine loop design
- Four bar, swivel configuration
- Beautifully polished chrome finish



Specifications

SKU	Finish	MSRP
TW-E4PCP	Polished Chrome	\$199
Size	28.5 in. H x 16.3 in. W x 3.5 in. D	
Voltage	120V	
Connection Type	5 ft. Plug-in Cord	
Watts	60 Watts	
Towel Bars	4	
Mounting	Wall Mounted	
Warranty	2 Years	

The Ibiza

The Ibiza towel warmer from WarmlyYours represents the perfect blend of versatility and functionality. With its freestanding construction and plug-in connection, the DIY-friendly Ibiza, unlike wall-mounted towel warmers, can be used in almost any room with a functioning outlet and easily moved to different locations.

Additionally, the integrated control offers several options: manual on/off control, on for 2 hours, and on for 4 hours. The 6 evenly spaced bars of the Ibiza towel warmer will deliver a heat output of 222 BTUs per hour, which will not only warm your towels and bathrobes but it can also dry them between uses.

- Polished, stainless steel construction and 6 heated bars
- Comes with built-in TempSmart™ protection to prevent overheating
- Integrated control with 3 modes: on/off, on for 2 hours, and on for 4 hours



Specifications

SKU	Finish	MSRP
TWS5-IBZ06PP	 Polished Stainless Steel	\$399
Size	34.84 in H x 21.85 in. W x 13.97 in. D	
Voltage	120V	
Connection Type	5 ft. Plug-in Cord	
Watts	65 Watts	
Towel Bars	6	
Mounting	Freestanding	
Warranty	5 Years	

The Barcelona

The freestanding and DIY-friendly Barcelona can be easily moved and used in any room in your home that has a 120 VAC outlet. Additionally, with the Barcelona's arched legs, 8 round bars, and brushed stainless steel finish, this towel warmer is also an attractive design element in any room.

The sleek Barcelona takes up very little floor space while still being able to accommodate two bath towels or a bathrobe to help keep them warm or dry between uses.

The Barcelona is safe and is cETLus listed. It comes with an LED power switch and TempSmart™ overheat protection to prevent the unit's surface temperature from exceeding 176°F (80°C).

- Freestanding for convenient placement and versatility
- Comes with built-in TempSmart™ protection to prevent overheating
- Easy to assemble and plugs into any standard 120 VAC outlet



Specifications

SKU	Finish	MSRP
TW-BC-08BS-FS2	 Brushed Stainless Steel	\$499
Size	37.0 in. H x 23.6 in. W x 15.5 in. D	
Voltage	120V	
Watts	150 Watts	
Connection Type	5 ft. Plug-in Cord	
Towel Bars	8	
Mounting	Freestanding	
Warranty	2 Years	

The Palma

The compact and economical Palma towel warmer from WarmlyYours provides all of the functionality of larger models, while taking up less wall space. The 4 evenly spaced bars have a heat output of 119 BTUs per hour, which means this unit will not only warm your towels and bathrobes but it can also dry them between uses.

This wall-mounted model, with its plug-in connection, is very DIY-friendly and its 304-stainless steel construction means that the Palma is durable and easy to maintain. The square bars, linear design, and highly polished finish means this unit will be a functional and attractive addition to any room.

- Polished, stainless steel construction and 4 heated bars
- Comes with built-in TempSmart™ protection to prevent overheating
- Integrated power switch with indicator light

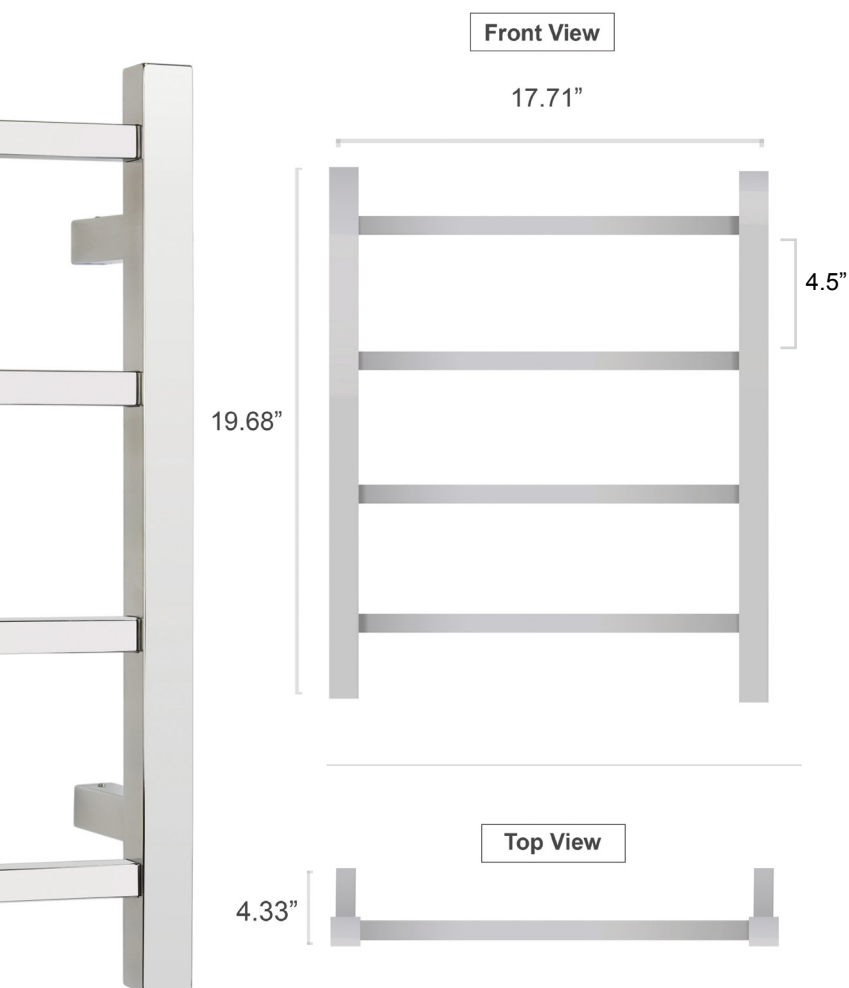

Specifications

SKU	Finish	MSRP
TWS2-PLM04PP	 Polished Stainless Steel	\$299
Size	19.68 in. H x 17.71 in. W x 4.3 in. D	
Voltage	120V	
Connection Type	5 ft. Plug-in Cord	
Watts	35 Watts	
Towel Bars	4	
Mounting	Wall Mounted	
Warranty	5 Years	

The Maple



The Maple towel warmer from WarmlyYours is a compact model that provides an enormous amount of functionality. The 8 flat, heated bars of this wall-mounted model help the Maple put out an impressive 358 BTUs per hour. The design also incorporates a spacing that allows the top pair of bars to perfectly accommodate hand towels.

The hardwired connection (120 VAC) ensures a streamlined appearance once installed. The Maple is available in either matte black or polished finishes. This model comes with built-in TempSmart™ protection to prevent the unit from overheating.

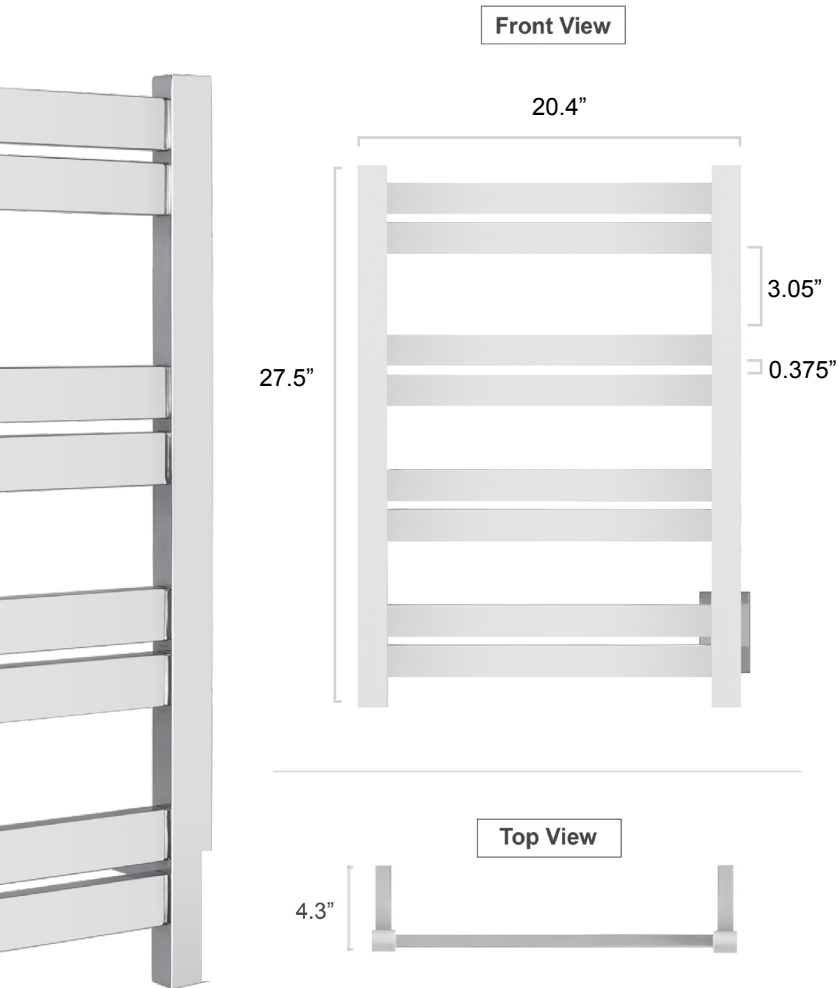
- Available with matte black or polished finishes
- Comes with built-in TempSmart™ protection to prevent overheating
- Integrated power switch with indicator light



Specifications

SKU	Finish	MSRP
TWS6-MPL08PH	 Polished Stainless Steel	\$499
TWS6-MPL08KH	 Matte Black Stainless Steel	\$599
Size	27.5 in. H x 20.4 in. W x 4.3 in. D	
Voltage	120V	
Connection Type	Hardwired, Bottom Right	
Watts	105 Watts	
Towel Bars	8	
Mounting	Wall Mounted	
Warranty	5 Years	
Optional Controls	Hardwired 4-Setting Countdown Timer Hardwired Programmable Timer Hardwired WiFi Switch	

The Tahoe 6

The compact and economical Tahoe 6 towel warmer provides all of the functionality of larger models while taking up significantly less wall space.

This wall-mounted model comes with a discrete power switch and a hardwired electrical connection, which means the Tahoe 6 will present a sleek profile when installed.

- Polished, stainless steel construction
- Comes with built-in TempSmart™ protection to prevent overheating
- Integrated power switch with indicator light

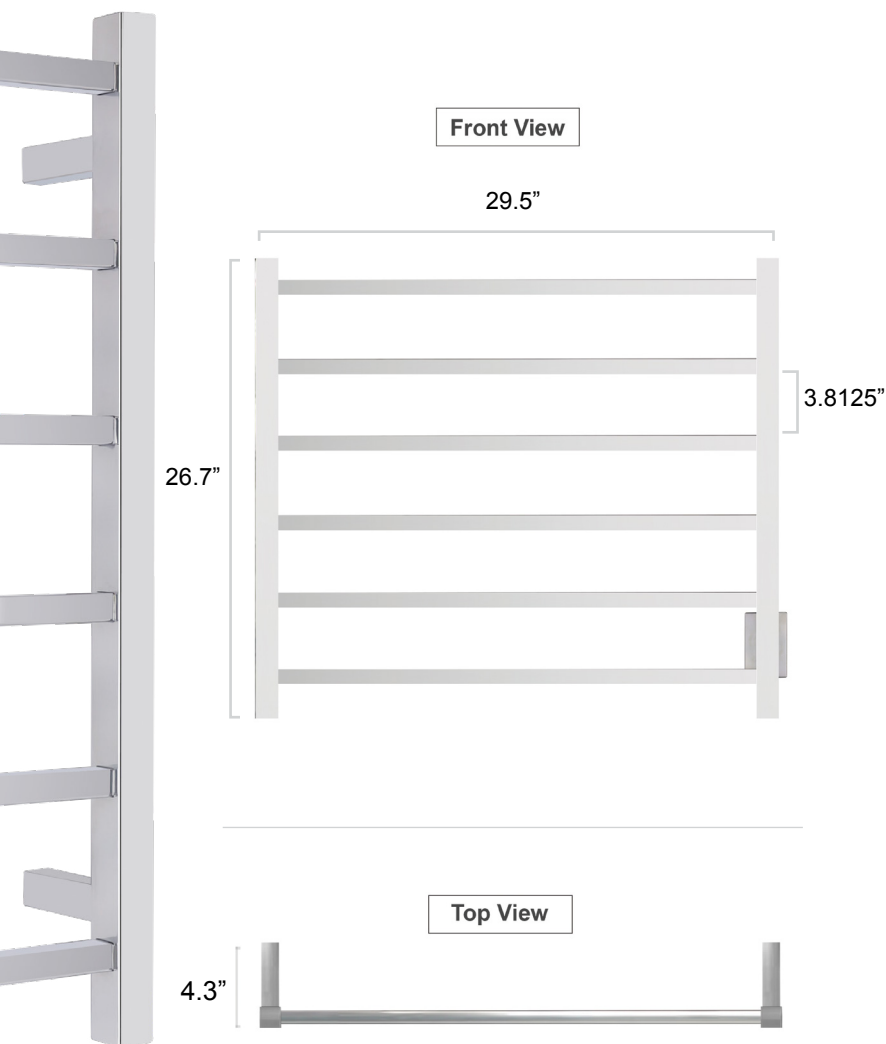

Specifications

SKU	Finish	MSRP
TWS2-TAH06PH	 Polished Stainless Steel	\$449
Size	26.7 in. H x 29.5 in. W x 4.3 in. D	
Voltage	120V	
Connection Type	Hardwired, Bottom Right	
Watts	80 Watts	
Towel Bars	6	
Mounting	Wall Mounted	
Warranty	5 Years	
Optional Controls	Hardwired 4-Setting Countdown Timer Hardwired Programmable Timer Hardwired WiFi Switch	

The Tahoe 7



Experience a new level of luxury with the Tahoe 7 towel warmer. This wall-mounted model comes with a discrete power switch and hardwired electrical connection.

The straight lines and square bars of the Tahoe 7 will be a perfect complement to the linear design aspects of most contemporary bathrooms.

- Available with brushed gold, matte black, or polished stainless steel finishes
- Comes with built-in TempSmart™ protection to prevent overheating
- Integrated power switch with indicator light



Specifications

SKU	Finish	MSRP
TWS2-TAH07PH	 Polished Stainless Steel	\$459
TWS2-TAH07KH	 Matte Black Stainless Steel	\$549
TWS2-TAH07GH	 Brushed Gold Stainless Steel	\$649
Size	31.5 in. H x 23.6 in. W x 4.3 in. D	
Voltage	120V	
Connection Type	Hardwired, Bottom Right	
Watts	75 Watts	
Towel Bars	7	
Mounting	Wall Mounted	
Warranty	5 Years	
Optional Controls	Hardwired 4-Setting Countdown Timer Hardwired Programmable Timer Hardwired WiFi Switch	

The Maui

The Maui towel warmer from WarmlyYours features an innovative design with an integrated, non-heating storage shelf for extra towels. With its compact design, this model delivers all of the functionality of larger units without taking up unnecessary wall-space.

The hardwired electrical connection for the wall-mounted Maui will provide a streamlined look without visible wires. The 7 heated bars will deliver a heat output of 222 BTUs per hour which will not only warm your towels and bathrobes but also dry them between uses.

The highly polished finish, 304-stainless steel construction, and curved design of the Maui means this towel warmer will instantly fit into any contemporary design motif.

- Polished stainless steel with 7 heated bars and an unheated shelf
- Comes with built-in TempSmart™ protection to prevent overheating
- Integrated power switch with indicator light

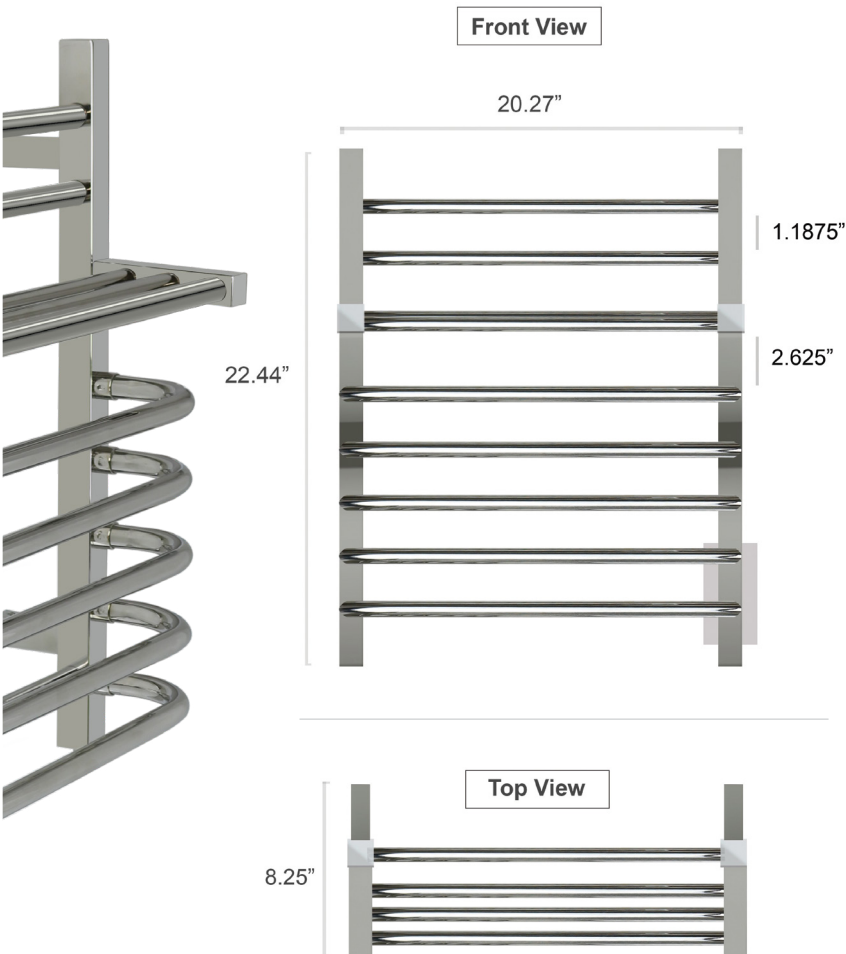

Specifications

SKU	Finish	MSRP
TWS1-MAU07PH	Polished Stainless Steel	\$599
Size	22.44 in. H x 20.27 in. W x 8.25 in. D	
Voltage	120V	
Connection Type	Hardwired, Bottom Right	
Watts	65 Watts	
Towel Bars	7 heated bars, and an integrated, non-heating storage shelf	
Mounting	Wall Mounted	
Warranty	5 Years	
Optional Controls	Hardwired 4-Setting Countdown Timer Hardwired Programmable Timer Hardwired WiFi Switch	

The Summit

The Summit is a truly innovative towel warmer that emphasizes both functionality and attractive, modern design. With 8 main heated bars, the Summit is able to accommodate 2 large towels or a bathrobe while the heated 3-bar shelf can keep additional towels toasty.



The Summit is dual connection, which means that it can be used "as is" to plug into a standard 120 VAC outlet or it can be modified by a licensed electrician to have a hardwired 120 VAC electrical connection.

The Summit is safe and is cETLus listed. It comes with an LED power switch and TempSmart™ overheat protection to prevent the unit's surface temperature from exceeding 167°F (75°C).

- 8 round main bars and a heated 3-bar top shelf
- Comes with built-in TempSmart™ protection to prevent overheating
- Use as is for a plug-in connection or modify for a hardwired connection



Specifications

SKU	Finish	MSRP
TW-SUM08PS-HP	 Polished Stainless Steel	\$699
TW-SUM08KS-HP	 Black Matte	\$1,099
Size	35.5 in. H x 19.625 in. W x 10.75 in. D	
Voltage	120V	
Connection Type	Dual Connection	
Watts	120 Watts	
Towel Bars	8 main bars and a 3-bar heated shelf	
Mounting	Wall Mounted	
Warranty	2 Years	
Optional Controls	Hardwired 4-Setting Countdown Timer Hardwired Programmable Timer Hardwired WiFi Switch	

The Sierra

The Sierra's eight square bars perfectly accommodate two bath towels or a bathrobe to help keep them warm or dry between uses. This towel warmer is also dual connection which means that it can be used "as is" to plug into a standard 120 VAC outlet or it can be modified by a licensed electrician to have a hardwired 120 VAC electrical connection.



When this towel warmer is installed with a hardwired electrical connection, there is no unattractive and cumbersome cover plate required because of its unique design.

The Sierra is safe and is cETLus listed. It comes with an LED power switch and TempSmart™ overheat protection to prevent the unit's surface temperature from exceeding 167°F (75°C).

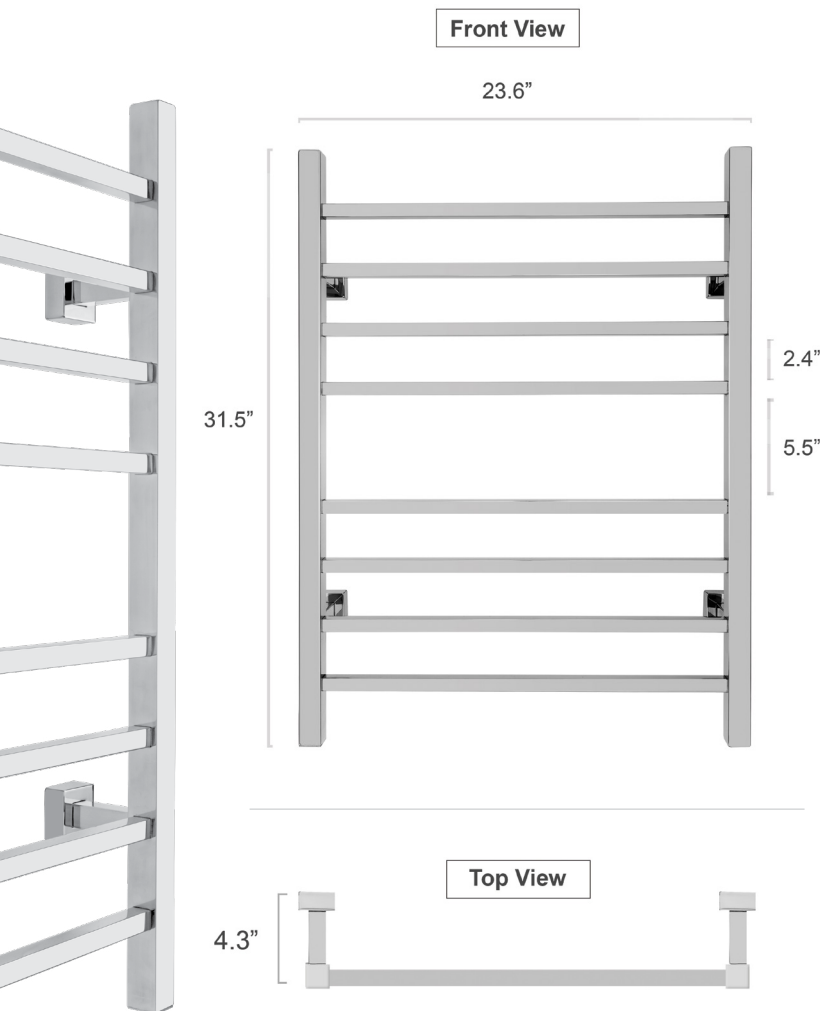
- Available with polished gold, matte black, or polished stainless steel finishes
- Comes with built-in TempSmart™ protection to prevent overheating
- Use as is for a plug-in connection or modify for a hardwired connection



Specifications

SKU	Finish	MSRP
TW-SR08PS-HP	 Polished Stainless Steel	\$649
TW-SR08KS-HP	 Matte Black Stainless Steel	\$679
TW-SR08GS-HP	 Polished Gold Stainless Steel	\$1,099
Size	31.5 in. H x 23.6 in. W x 4.3 in. D	
Voltage	120V	
Connection Type	Dual Connection	
Watts	150 Watts	
Towel Bars	8	
Mounting	Wall Mounted	
Warranty	2 Years	
Optional Controls	Hardwired 4-Setting Countdown Timer Hardwired Programmable Timer Hardwired WiFi Switch	

The Riviera

The Riviera is another dual connection towel warmer, which means that it can be used “as is” to plug into a standard 120 VAC outlet or it can be modified by a licensed electrician to have a hardwired 120 VAC electrical connection.

When this towel warmer is installed with a hardwired electrical connection, there is no unattractive and cumbersome cover plate required because of its unique design.

The Riviera is safe and is cETLus listed. It comes with an LED power switch and TempSmart™ overheat protection to prevent the unit’s surface temperature from exceeding 167°F (75°C).

- 9 curved stainless steel bars to evenly distribute heat
- Comes with built-in TempSmart™ protection to prevent overheating
- Use as is for a plug-in connection or modify for a hardwired connection



Front View

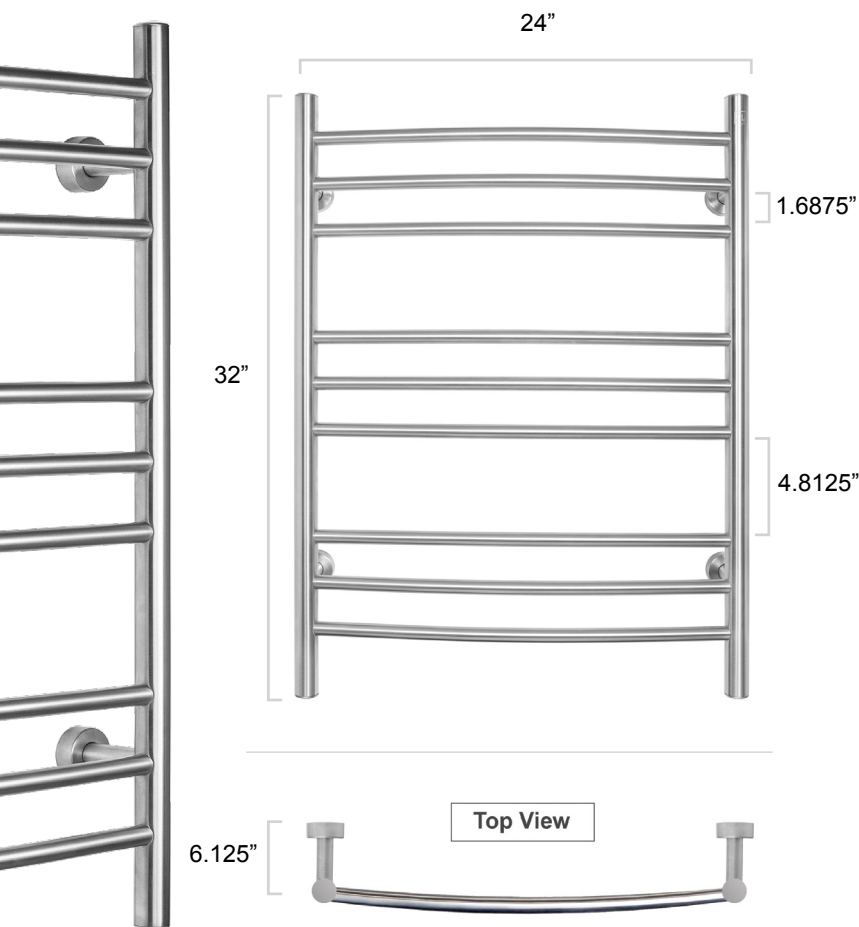

Specifications

SKU	Finish	MSRP
TW-R09BS-HP	Brushed Stainless Steel	\$649
TW-R09PS-HP	Polished Stainless Steel	\$649
Size	32 in. H x 24 in. W x 6.125 in. D	
Voltage	120V	
Connection Type	Dual Connection	
Watts	150 Watts	
Towel Bars	9	
Mounting	Wall Mounted	
Warranty	2 Years	
Optional Controls	Hardwired 4-Setting Countdown Timer Hardwired Programmable Timer Hardwired WiFi Switch	

The Infinity

The Infinity towel warmer is dual connection, meaning it can be used “as is” to plug into a standard 120 VAC outlet or it can be modified by a licensed electrician to have a hardwired 120 VAC electrical connection.

And when this towel warmer is installed with a hardwired electrical connection, its unique design means there is no unattractive and cumbersome cover plate required.

The Infinity comes with an LED power switch and TempSmart™ overheating protection to prevent the unit’s surface temperature from exceeding 167°F (75°C).

- Available with polished, brushed, or matte black finishes
- Built-in TempSmart™ protection prevents overheating
- Use as is for a plug-in connection or modify for a hardwired connection

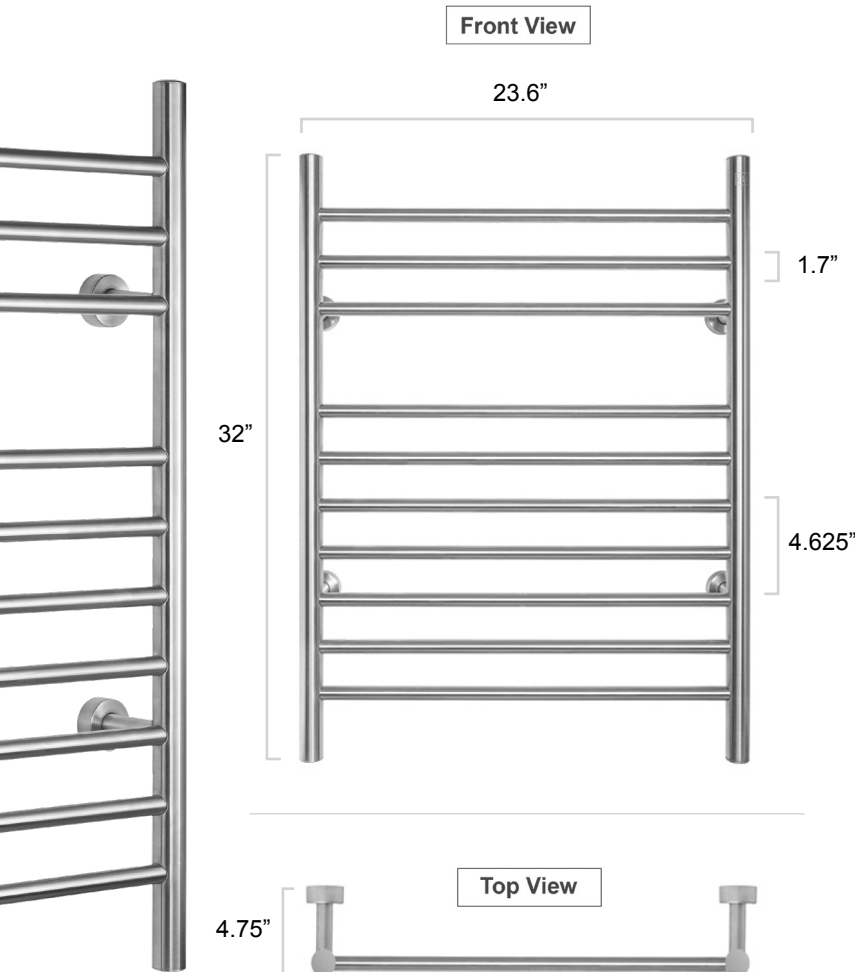

Specifications

SKU	Finish	MSRP
TW-F10BS-HP	Brushed Stainless Steel	\$599
TW-F10PS-HP	Polished Stainless Steel	\$599
TW-F10KS-HP	Matte Black Stainless Steel	\$629
Size	32 in. H x 23.6 in. W x 4.75 in. D	
Voltage	120V	
Connection Type	Dual Connection	
Watts	150 Watts	
Towel Bars	10	
Mounting	Wall Mounted	
Warranty	2 Years	
Optional Controls	Hardwired 4-Setting Countdown Timer Hardwired Programmable Timer Hardwired WiFi Switch	

The Metropolitan

With this towel warmer's polished finish and crisp, strong lines, the Metropolitan makes an immediate visual impact in any room. With two groups of five heated bars, this towel warmer has more than enough room to accommodate two large towels (or a bathrobe).

This towel warmer is also dual connection which means that it can be used "as is" to plug into a standard 120 VAC outlet or it can be modified by a licensed electrician to have a hardwired 120 VAC electrical connection. When this towel warmer is installed with a hardwired electrical connection, there is no unattractive and cumbersome cover plate required because of its unique design.

The Metropolitan is safe and is cETLus listed. It comes with an LED power switch and TempSmart™ overheat protection to prevent the unit's surface temperature from exceeding 167°F (75°C).

- 10 squared, polished stainless steel bars to evenly distribute heat
- Comes with built-in TempSmart™ protection to prevent overheating
- Use as is for a plug-in connection or modify for a hardwired connection

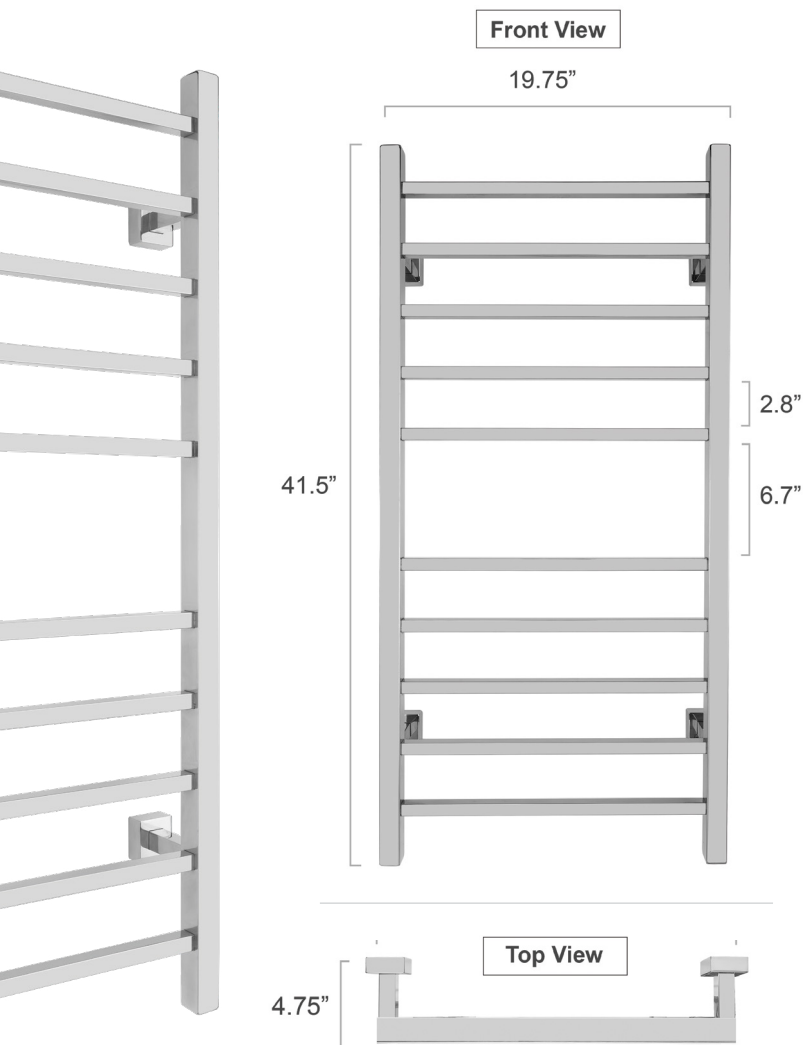

Specifications

SKU	Finish	MSRP
TW-MT-10PS-HP	Polished Stainless Steel	\$849
Size	41.5 in. H x 19.75 in. W x 4.75 in. D	
Voltage	120V	
Connection Type	Dual Connection	
Watts	150 Watts	
Towel Bars	10	
Mounting	Wall Mounted	
Warranty	2 Years	
Optional Controls	Hardwired 4-Setting Countdown Timer Hardwired Programmable Timer Hardwired WiFi Switch	

The Rome

The Rome towel warmer from WarmlyYours has a boldly modern design with an emphasis on high performance. This wall-mounted model comes with 10 heated bars which help the Rome put out an impressive 426 BTUs per hour.

The three-dimensional cross-lay of the round bars ensures the Rome will be able to warm or dry your towels and bathrobes. When installed, the hardwired electrical connection (120 VAC) of this model means there will be no visible wires or cords.

The Rome comes with a brushed finish and a durable 304-stainless steel construction which help add to the modern, industrial-chic appearance of this model. This model comes with built-in TempSmart™ overheat protection to prevent the unit's surface temperature from exceeding 149°F (65°C).

- Brushed, stainless steel construction and 10 heated bars
- Comes with built-in TempSmart™ protection to prevent overheating
- Integrated power switch with indicator light

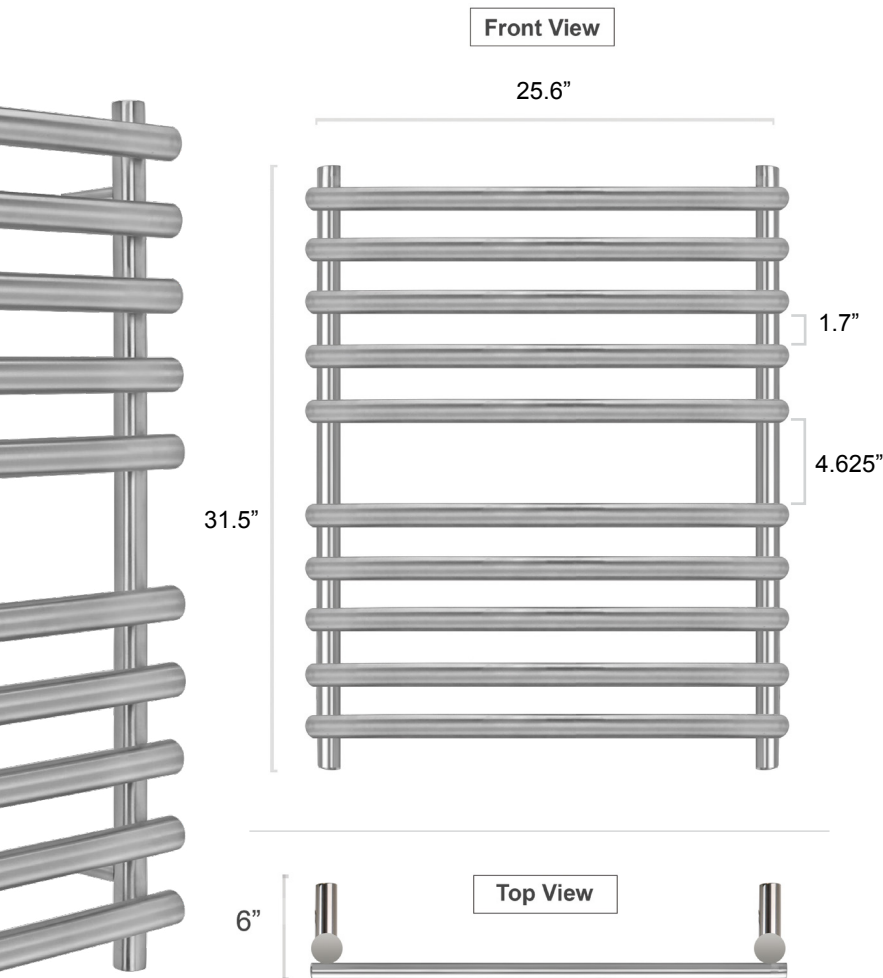

Specifications

SKU	Finish	MSRP
TWS7-ROM10BH	 Brushed Stainless Steel	\$599
Size	31.5 in. H x 25.6 in. W x 6 in. D	
Voltage	120V	
Connection Type	Hardwired, Bottom Right	
Watts	125 Watts	
Towel Bars	10	
Mounting	Wall Mounted	
Warranty	5 Years	
Optional Controls	Hardwired 4-Setting Countdown Timer Hardwired Programmable Timer Hardwired WiFi Switch	

The Malta

The Malta towel warmer from WarmlyYours is a large, stunning model designed with an emphasis on both form and function. This wall-mounted model features 11 heated, round bars. The Malta has an impressive heat output of 443 BTUs per hour, which will help warm your towels and bathrobes along with drying them in between uses.



The number of bars, and their orientation in the assembly, means this model will be able to accommodate a large variety of towel shapes and sizes. This model's hardwired connection (120 VAC) provides a streamlined look without visible wires.

The Malta is made from stainless steel and is available with either polished or matte black finishes. This model comes with built-in TempSmart™ overheat protection to prevent the unit's surface temperature from exceeding 149°F (65°C).

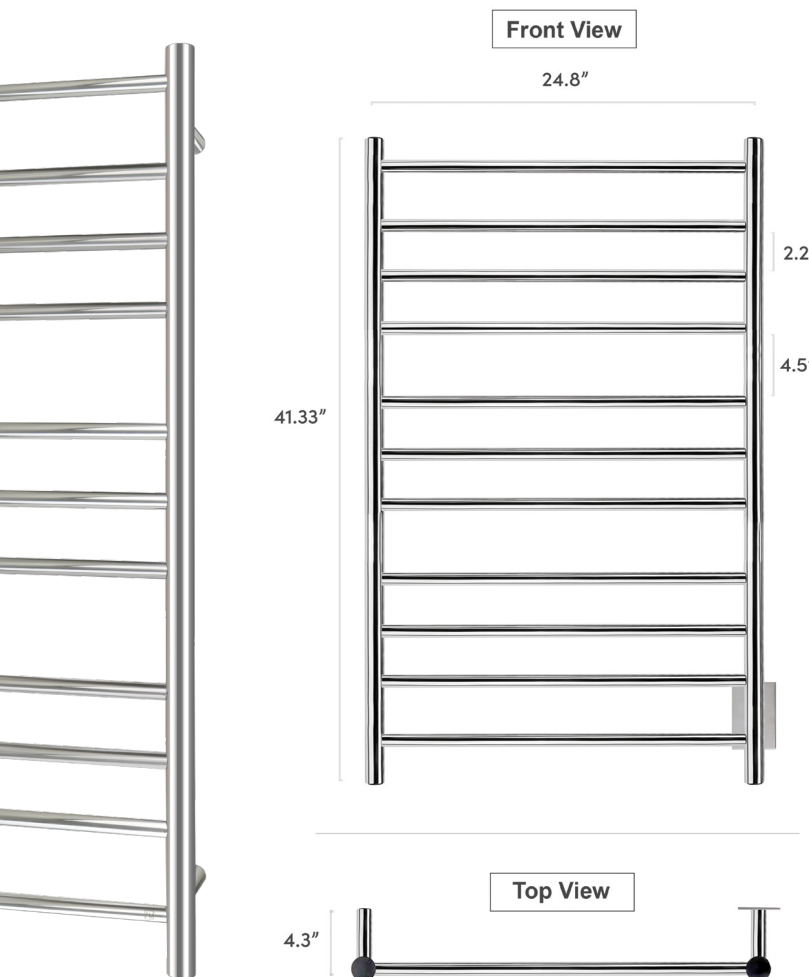
- Durable stainless steel construction and 11 heated bars
- Comes with built-in TempSmart™ protection to prevent overheating
- Integrated power switch with indicator light



Specifications

SKU	Finish	MSRP
TWS4-MLT11PH	 Polished Stainless Steel	\$499
TWS4-MLT11KH	 Matte Black Stainless Steel	\$599
Size	41.3 in. H x 24.8 in. W x 4.3 in. D	
Voltage	120V	
Connection Type	Hardwired, Bottom Right	
Watts	130 Watts	
Towel Bars	11	
Mounting	Wall Mounted	
Warranty	5 Years	
Optional Controls	Hardwired 4-Setting Countdown Timer Hardwired Programmable Timer Hardwired WiFi Switch	

The Vida

A towel warmer is more than a simple appliance—it's a gateway to a level of comfort previously only available in expensive spas. The Vida electric towel warmer from WarmlyYours is a large luxuriant model with 21 heated bars spaced out in groups of 4, 7, and 10.

The large number of bars and their orientation ensures you'll be able to warm and dry a wide range of towels, bathrobes, and more. The Vida also boasts an impressive heat output rate of 716 BTUs per hour.

The polished 304 stainless steel finish and curved design allows the Vida to fit organically into any aesthetic. This model comes with built-in TempSmart™ overhear protection to prevent the unit's surface temperature from exceeding 149°F (65°C).

- Polished, stainless steel construction and 21 heated bars
- Comes with built-in TempSmart™ protection to prevent overheating
- Integrated power switch with indicator light

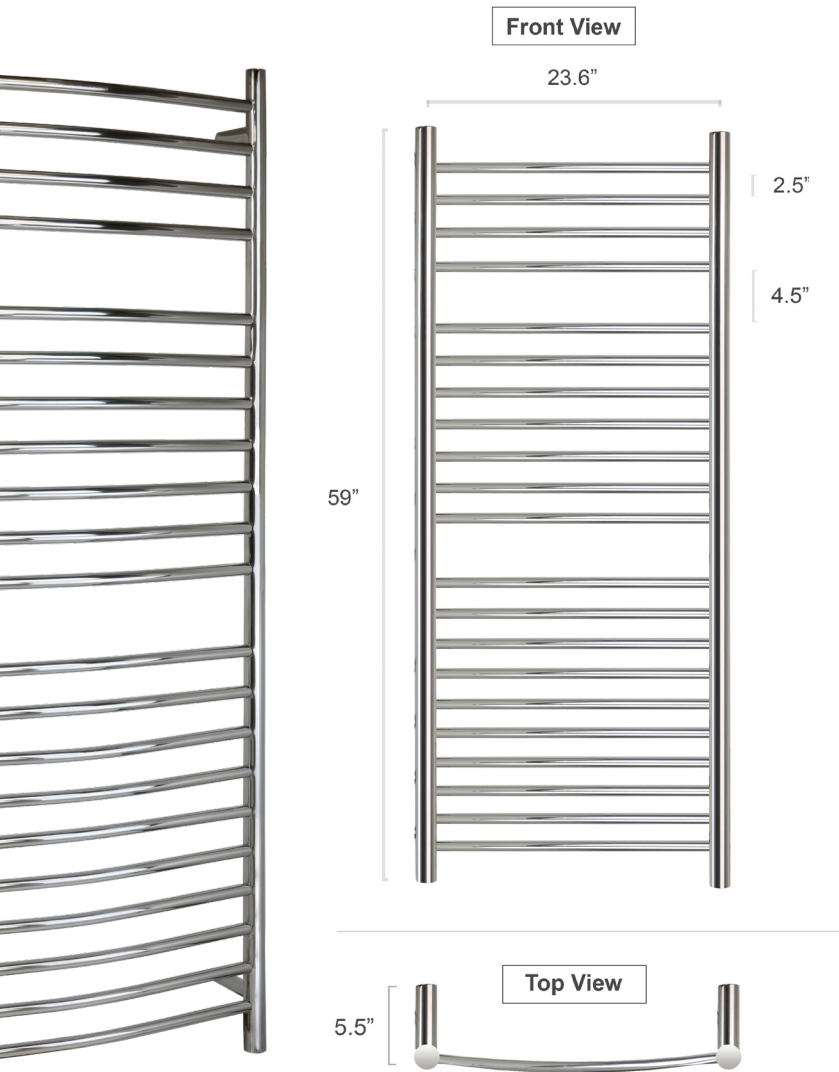

Specifications

SKU	Finish	MSRP
TWS3-VID21PH	 Polished Stainless Steel	\$999
Size	59 in. H x 23.6 in. W x 5.5 in. D	
Voltage	120V	
Connection Type	Hardwired, Bottom Right	
Watts	210 Watts	
Towel Bars	21	
Mounting	Wall Mounted	
Warranty	5 Years	
Optional Controls	Hardwired 4-Setting Countdown Timer Hardwired Programmable Timer Hardwired WiFi Switch	

Elevate Collection



The **Elevate Towel Warmer Collection** by WarmlyYours is sold by Authorized Online Retailers.

Find where to purchase at
[WarmlyYours.com/towel-warmer](https://www.warmlyyours.com/towel-warmer)

The Ontario XL

There's no doubt that a towel warmer delivers comfort and luxury, but the Ontario XL from WarmlyYours is a perfect example of how functional an electric towel warmer can be.

The economical Ontario XL's distinctive size offers two immediate benefits: it can easily accommodate multiple towels and its heat output of 443 BTUs per hour is hard to beat for the price. The heat is delivered through 11 round bars that are spaced in groups of 4, 3, and 4. This orientation makes the Ontario XL well suited for heating and drying towels of different sizes.

The polished finish and hardwired connection of this model is both streamlined and aesthetically pleasing. This model comes with built-in TempSmart™ overheat protection to prevent the unit's surface temperature from exceeding 149°F (65°C).

- Polished, stainless steel construction and 11 heated bars
- Comes with built-in TempSmart™ protection to prevent overheating
- Integrated power switch with indicator light



Specifications

SKU	Finish	MSRP
TWS4-ONT11PH	 Polished Stainless Steel	\$499
Size	45.27 in. H x 23.6 in. W x 4.4 in. D	
Voltage	120V	
Connection Type	Hardwired, Bottom Right	
Watts	130 Watts	
Towel Bars	11	
Mounting	Wall Mounted	
Warranty	5 Years	
Optional Controls	Hardwired 4-Setting Countdown Timer Hardwired Programmable Timer Hardwired WiFi Switch	

The Grande 10

If the Grande 10 towel warmer from WarmlyYours proves anything, it's that sometimes huge performance comes in small packages. It's heat output of 460 BTUs per hour stands toe-to-toe with many larger models, while its compact profile means the Grande 10 can be installed in a variety of locations.

The flat bars of the Grande 10 provide ample surface area to heat and dry your towels and bathrobes. The spacing of the bars also incorporates a specialized top-bar pairing for hand towels. This wall-mounted model features a hardwired electrical connection (110 – 120 VAC), discrete power switch, 304-stainless steel construction, and is available with matte black, brushed, or polished finishes.

This model comes with built-in TempSmart™ overheat protection to prevent the unit's surface temperature from exceeding 149°F (65°C).

- Stainless steel construction and 10 heated bars
- Comes with built-in TempSmart™ protection to prevent overheating
- Integrated power switch with indicator light

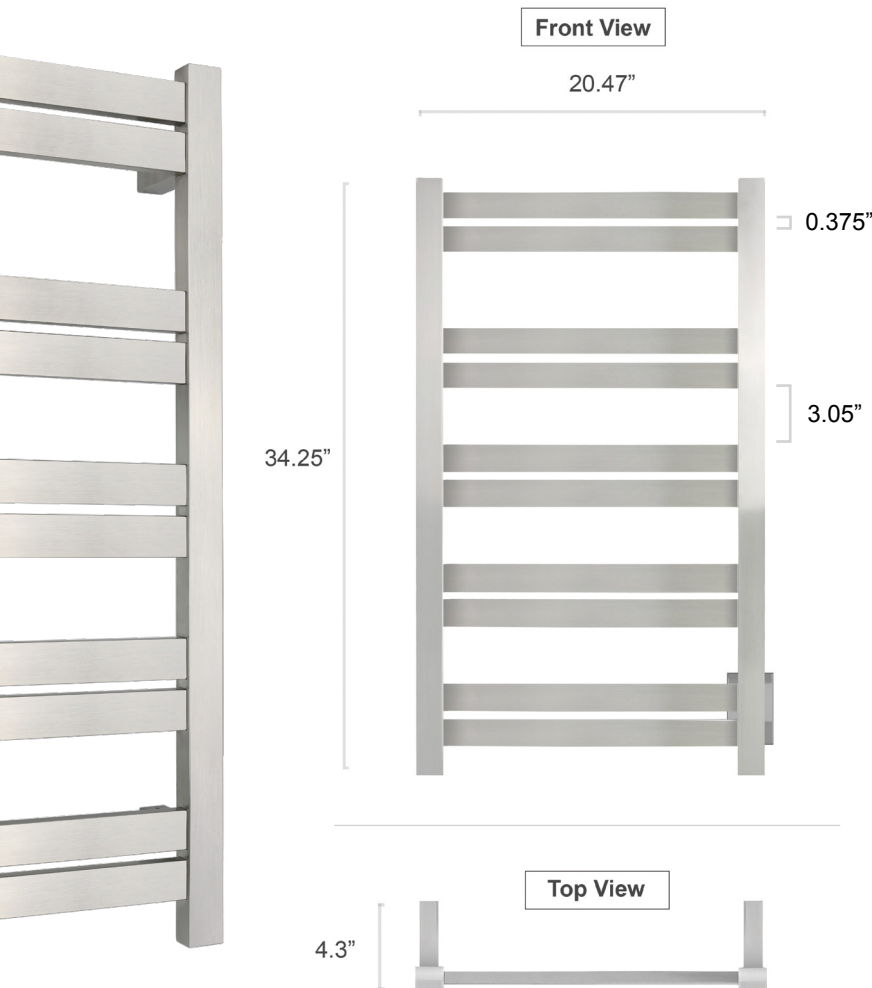

Specifications

SKU	Finish	MSRP
TWS6-GRD10BH	Brushed Stainless Steel	\$699
TWS6-GRD10PH	Polished Stainless Steel	\$799
TWS6-GRD10KH	Matte Black Stainless Steel	\$799
Size	34.25 in. H x 20.47 in. W x 4.3 in. D	
Voltage	120V	
Connection Type	Hardwired, Bottom Right	
Watts	135 Watts	
Towel Bars	10	
Mounting	Wall Mounted	
Warranty	5 Years	
Optional Controls	Hardwired 4-Setting Countdown Timer Hardwired Programmable Timer Hardwired WiFi Switch	

The Grande 12

The Grande 12 towel warmer from WarmlyYours is a stunning model designed with an emphasis on both form and function. With its 12 heated, flat bars and high heat output of 597 BTUs per hour, this model is one of the most powerful electric towel warmers for its size.



The flat bars of the Grande 12 provide a large amount of heating surface to help warm and dry your towels and bathrobes. This wall-mounted model features a discrete power switch and a hardwired electrical connection (110 – 120 VAC).

This model comes with built-in TempSmart™ overheat protection to prevent the unit's surface temperature from exceeding 149°F (65°C).

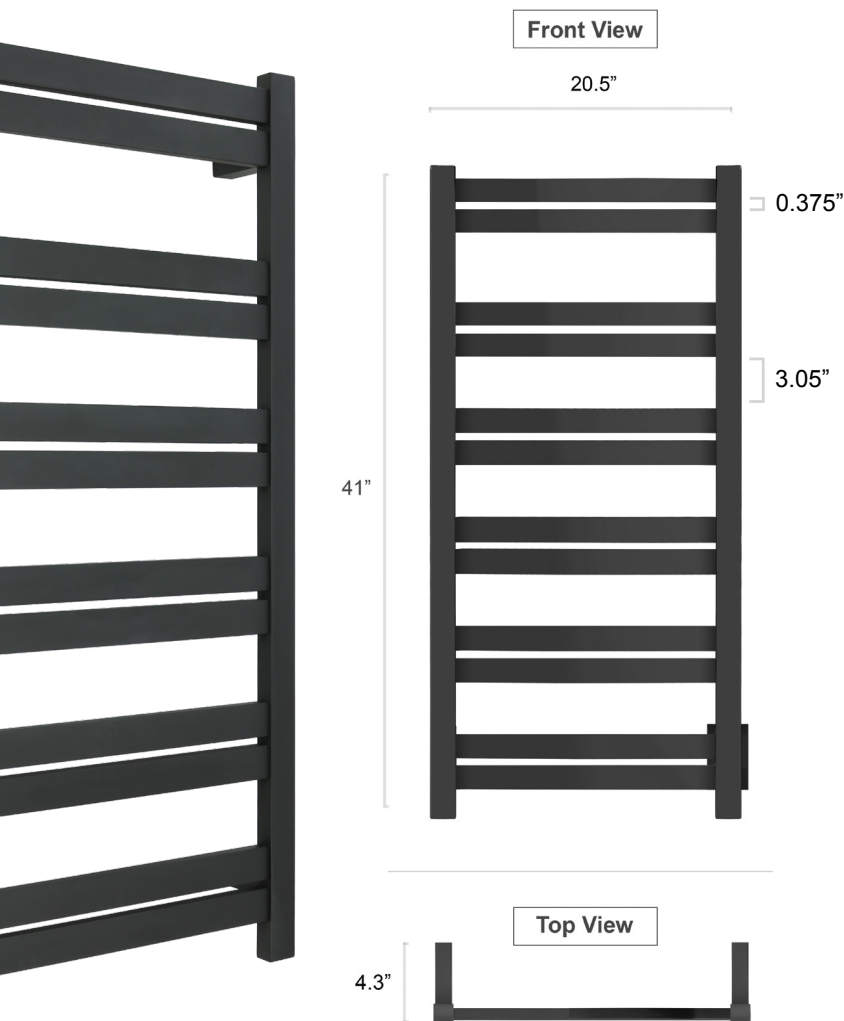
- Stainless steel construction and 12 heated bars
- Comes with built-in TempSmart™ protection to prevent overheating
- Integrated power switch with indicator light



Specifications

SKU	Finish	MSRP
TWS6-GRD12PH	 Polished Stainless Steel	\$899
TWS6-GRD12KH	 Matte Black Stainless Steel	\$999
Size	41 in. H x 20.5 in. W x 4.3 in. D	
Voltage	120V	
Connection Type	Hardwired, Bottom Right	
Watts	175 Watts	
Towel Bars	12	
Mounting	Wall Mounted	
Warranty	5 Years	
Optional Controls	Hardwired 4-Setting Countdown Timer Hardwired Programmable Timer Hardwired WiFi Switch	

Crystal Towel Warmer Accents



Upgrade your Infinity or Riviera Dual Connection Towel Warmer with beautiful Austrian Crystal Towel Warmer Accents!

Shop Crystal Towel Warmer Accents at [WarmlyYours.com/towel-warmer-crystal](https://www.warmlyyours.com/towel-warmer-crystal)

Crystal Towel Warmer Accents

Towel warmers have always been luxurious bathroom appliances but now they can also become a bold personal statement of your unique style with Crystal Towel Warmer Accents from WarmlyYours.

These attractive upgrades consist of stainless steel collars (available in 3 different finishes) capped with Austrian crystals in 4 distinct patterns (Slate, Platinum, Midnight, and Spice). The 4 collars are then placed on the towel warmer's legs so that they're still visible even when the device is heating a towel.

The Austrian crystals, which have been securely attached by our skilled craftsmen, are cut and arranged to ensure maximum luster and reflectivity, which is sure to add an extra touch of beauty in any lighting. Finally, you can make your towel warmers look as radiant as they feel!

Compatible Models:

Crystal Towel Warmer Accents are compatible with the following models:

Model

Infinity Dual Connection
Towel Warmer

Riviera Dual Connection
Towel Warmer



If you're also considering adding a Hardwired WiFi Switch control to your order, you can pair your Crystal Towel Warmer Accents with a control that has a matching crystal pattern.

Crystal Patterns:

We offer 4 different crystal patterns to ensure you can find the perfect complement to your towel warmer.

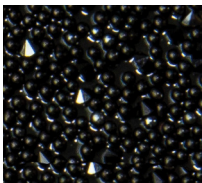

"Midnight" with crystal colors ranging from volcanic glass to inky night and onyx

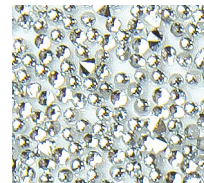

"Platinum" with crystal colors ranging from dove gray to pearl and royal silver

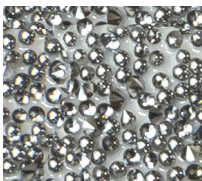

"Slate" with crystal colors ranging from pewter to sharkskin gray and silver

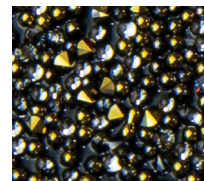

"Spice" with crystal colors ranging from champagne to amber and antique gold

Infinity Towel Warmer with Crystal Accents



Infinity Towel Warmer,
Midnight on Brushed Steel,
Dual Connection, 10 Bars

TW-F10BS-MD-HP | \$689



Infinity Towel Warmer,
Platinum on Brushed Steel,
Dual Connection, 10 Bars

TW-F10BS-PT-HP | \$679



Infinity Towel Warmer,
Slate on Brushed Steel,
Dual Connection, 10 Bars

TW-F10BS-SL-HP | \$679



Infinity Towel Warmer,
Spice on Brushed Steel,
Dual Connection, 10 Bars

TW-F10BS-SP-HP | \$699



Infinity Towel Warmer,
Midnight on Matte Black,
Dual Connection, 10 Bars

TW-F10KS-MD-HP | \$729



Infinity Towel Warmer,
Platinum on Matte Black,
Dual Connection, 10 Bars

TW-F10KS-PT-HP | \$719



Infinity Towel Warmer,
Slate on Matte Black,
Dual Connection, 10 Bars

TW-F10KS-SL-HP | \$719



Infinity Towel Warmer,
Spice on Matte Black,
Dual Connection, 10 Bars

TW-F10KS-SP-HP | \$739



Infinity Towel Warmer,
Midnight on Polished Steel,
Dual Connection, 10 Bars

TW-F10PS-MD-HP | \$689



Infinity Towel Warmer,
Platinum on Polished Steel,
Dual Connection, 10 Bars

TW-F10PS-PT-HP | \$679



Infinity Towel Warmer,
Slate on Polished Steel,
Dual Connection, 10 Bars

TW-F10PS-SL-HP | \$679



Infinity Towel Warmer,
Spice on Polished Steel,
Dual Connection, 10 Bars

TW-F10PS-SP-HP | \$699

Riviera Towel Warmer with Crystal Accents



Riviera Towel Warmer,
Midnight on Brushed Steel,
Dual Connection, 10 Bars

TW-R09BS-MD-HP | \$749



Riviera Towel Warmer,
Platinum on Brushed Steel,
Dual Connection, 10 Bars

TW-R09BS-PT-HP | \$739



Riviera Towel Warmer,
Slate on Brushed Steel,
Dual Connection, 10 Bars

TW-R09BS-SL-HP | \$739



Riviera Towel Warmer,
Spice on Brushed Steel,
Dual Connection, 10 Bars

TW-R09BS-SP-HP | \$759.00



Riviera Towel Warmer,
Midnight on Polished Steel,
Dual Connection, 10 Bars

TW-R09PS-MD-HP | \$749



Riviera Towel Warmer,
Platinum on Polished Steel,
Dual Connection, 10 Bars

TW-R09PS-PT-HP | \$739



Riviera Towel Warmer,
Slate on Polished Steel,
Dual Connection, 10 Bars

TW-R09PS-SL-HP | \$739



Riviera Towel Warmer,
Spice on Polished Steel,
Dual Connection, 10 Bars

TW-R09PS-SP-HP | \$759.00

Hardwired Controls



Find the perfect
control for your
towel warmer with a
hardwired connection.

We're here to help you choose the best control for your towel warmer or radiant panel heater. If you have any questions, speak to a radiant heating expert at WarmlyYours.com/contact or call us at **800-875-5285**.



4-Setting
Countdown
Timer



Hardwired
Programmable
Timer



Hardwired
WiFi Switch
(White)



Hardwired
WiFi Switch
(Black)

SKU

MSRP

SKU

MSRP

SKU

MSRP

SKU

MSRP

GK16-30090-0001

\$69

GK16-30090-0002

\$89

GK16-30090-0003

\$109

GK16-30090-0003-B

\$119

Features

- 4 different countdown settings (2hr, 1hr, 30min, and 15min) and an on/off button
- Comes with 3 interchangeable faceplates: white (installed), ivory, and light almond

- Easy-to-program with up to 50 on/off events possible and built-in astronomical clock
- Comes with 3 interchangeable faceplates: white (installed), ivory, and light almond

- Can be controlled/programmed remotely with a smart device running iOS or Android
- Voice control using Amazon Alexa and Google Assistant. Also works with Nest & IFTTT
- Comes with a white faceplate and a white wallplate

- Can be controlled/programmed remotely with a smart device running iOS or Android
- Voice control using Amazon Alexa and Google Assistant. Also works with Nest & IFTTT
- Comes with a black faceplate and a black wallplate

Warranty

5 Years

5 Years

5 Years

5 Years

Max Load

20 Amps

15 Amps

15 Amps

15 Amps

Certifications

cCSAus listed

cCSAus listed

cCSAus listed

cCSAus listed

We're here to help you choose the best control for your towel warmer or radiant panel heater. If you have any questions, speak to a radiant heating expert at WarmlyYours.com/contact or call us at **800-875-5285**.



Hardwired WiFi Switch with Slate Austrian Crystals



Hardwired WiFi Switch with Platinum Austrian Crystals



Hardwired WiFi Switch with Midnight Austrian Crystals



Hardwired WiFi Switch with Spice Austrian Crystals

SKU	MSRP	SKU	MSRP	SKU	MSRP	SKU	MSRP
GK16-03-SC-SL-W	\$219	GK16-03-SC-PT-W	\$219	GK16-03-SC-MD-B	\$229	GK16-03-SC-SP-B	\$234

Features	<ul style="list-style-type: none"> Comes with a white faceplate and a white wallplate covered in "Slate" pattern Austrian crystals Can be controlled/programmed remotely with a smart device running iOS or Android Voice control using Amazon Alexa and Google Assistant. Also works with Nest & IFTTT 	<ul style="list-style-type: none"> Comes with a white faceplate and a white wallplate covered in "Platinum" pattern Austrian crystals Can be controlled/programmed remotely with a smart device running iOS or Android Voice control using Amazon Alexa and Google Assistant. Also works with Nest & IFTTT 	<ul style="list-style-type: none"> Comes with a black faceplate and a black wallplate covered in "Midnight" pattern Austrian crystals Can be controlled/programmed remotely with a smart device running iOS or Android Voice control using Amazon Alexa and Google Assistant. Also works with Nest & IFTTT 	<ul style="list-style-type: none"> Comes with a black faceplate and a black wallplate covered in "Spice" pattern Austrian crystals Can be controlled/programmed remotely with a smart device running iOS or Android Voice control using Amazon Alexa and Google Assistant. Also works with Nest & IFTTT 	
	Warranty	5 Years	5 Years	5 Years	5 Years
	Max Load	15 Amps	15 Amps	15 Amps	15 Amps
	Certifications	cCSAus listed	cCSAus listed	cCSAus listed	cCSAus listed

Showroom Display Program

Let your customers feel the warmth and comfort for themselves

50% OFF MSRP
rebated with your
first order*

Order one for your
showroom today!

First order can be of any
WarmlyYours products.
Ground shipping not included.
Standard rates will apply.

Features/Benefits:

- Add incremental sales to your business with WarmlyYours radiant products collection
- Generate interest for new and existing customers
- Many models and sizes available to best suit your showroom design

Infinity Black



Sierra Polished Gold



Riviera Polished



* Offer is valid for one display per showroom. It cannot be combined with any other promotion. 50% of the item's price will need to be paid at the time of the order, which will be rebated on your first purchase after the showroom sale. Other restrictions may apply.

Frequently Asked Questions

Can I install the towel warmer myself or do I need to hire someone to do it for me?

- Each towel warmer comes with an instruction manual which fully explains how to install the device from start to finish. If you can hang a picture, you can probably install a heated towel rack. However, for hardwired models, you will need a licensed professional who is certified to do electrical wiring for the final hook-up.

How hot does the towel warmer actually get and is there any possibility of damage?

- The heated towel rack will heat up to between 100 and 140 degrees Fahrenheit. It will not produce sufficient heat to injure you if you touch or brush up against it, though you should still exercise caution around the device. Please note that once a heated towel rail is warmed up, the surface temperature will remain constant and can't be adjusted incrementally.

The heated towel racks have a built-in offset from the wall (the size of the offset will depend on which model you purchased); the offset provides sufficient clearance to prevent any damage to the wall. You should also maintain a distance of four inches between the towel warmer and surrounding fixtures.

Additionally, nearly all of our electric towel warmer models* come with built-in TempSmart™ overheat protection which will shut the unit down automatically if the unit's surface exceeds the safety limit of between 149°F (65°C) and 167°F (75°C).

How much does it cost to operate a towel warmer?

- The cost to operate your model will depend on two different variables: 1.) the wattage of the model you've selected. 2.) the cost of electricity in your area.

A quick way to figure out the hourly operating cost is to take the cost of electricity in your area (typically measured in cents per kilowatt hour) and multiple it by the wattage of your towel warmer divided by 1000. For example, the cost to operate an Infinity Towel Warmer (a 150-watt model) in Lake Zurich, IL (where electricity costs 10.44 cents per kilowatt hour) would be less than 2 cents an hour and the formula to figure that out would look like this: $\$0.1044 \times (150/1000) = \0.0156 per hour.

How do I use the towel warmer after it is installed?

- Our towel warmers are designed for everyday use and all of them include an integrated on/off switch. Please note that the Ibiza model includes additional built-in timer options for controlling the unit. WarmlyYours also offers a wide array of controls that can be used with your heated towel rack. Depending on the control you select, you can program the heated towel rack to your schedule or operate it remotely. Just bear in mind that the heated towel rack is designed to gradually warm towels over the course of a day and does work best when towels are left to hang for about 3 hours.

Does the towel warmer have an automatic shutoff function?

- The heated towel rack is designed to stay on at a relatively constant temperature to keep your bathrobes and towels fresh, warm, and dry. However, should you need to turn the unit off for any reason, you can use the integrated on/off switch on the unit. If you're using a control for your heated towel rack, you may need to shut off the unit there as well.

Most of our electric towel warmer models* come with built-in TempSmart™ overheat protection which will shut the unit down automatically if the unit's surface exceeds the safety limit of between 149°F (65°C) and 167°F (75°C).

*Excludes the Elements model.

How close can a towel warmer be installed to a shower or tub?

Can it be mounted in a shower enclosure?

- A towel warmer can't be installed in a shower enclosure. A heated towel rack needs to be installed at least 24" away from a wet location like a shower, tub, etc. You'll also want to check your local electrical code prior to installation.

Can I control the towel warmer via Amazon's Alexa or Google Assistant?

- Yes, when using our Hardwired WiFi Switch which works with Amazon's Alexa, Google Assistant, or the Nest Thermostat (no hub required).

Can a towel warmer warm up a bathroom?

- Yes. A heated towel rack can be used as a supplementary heat source, but in most cases they don't generate enough ambient heat in a room to be used as a primary heat source.

Can a towel warmer be left on all the time?

- Yes, your unit is designed to be left on 24/7 if needed. However, for efficient operation, you may want to pair your heated towel rail with a compatible WarmlyYours control.



Be Connected.
Be Warm. Be Radiant.

WarmlyYours HQ 
590 Telser Road,
Lake Zurich, IL 60047

WarmlyYours 
300 Granton Drive, Unit 4A
Richmond Hill, ON L4B1H7

WarmlyYours 
Blaak 520 3011 TA
Rotterdam, Netherlands

800-875-5285
www.WarmlyYours.com

Connect with Us



Industry leading 24/7 installation and technical support.
Our experts can answer any technical questions on
any product we offer, 24/7.



Scan here to
learn more about
Towel Warmers

Ask us about our Floor Heating,
Outdoor Heating and Radiant
Heating Panel Catalogs.

Pricing subject to change without notification.